



立得微电子（惠州）有限公司  
Leader Micro Electronics (huizhou) Co., Ltd

# 产品规格书

## PRODUCT SPECIFICATION

客户	客户名称/Customer		
	客户料号/Part No.		
	客户承认签章 Customer Approved Signatures		
敝 司	文件编号/Spec No.	LEADER-Z-0408442015	
	品名 Description	圆柱直流马达 Cylindrical DC Motor	
	型号/Model	LCM0408442015	
	送样日期/Date		
	作成/Designed	检讨/checked	承认/Approved
	张亭亭 2022.06.14	张冠军 2022.06.14	王远东 2022.06.14

立得微电子（惠州）有限公司

Leader Micro Electronics (Huizhou) Co., Ltd.

Tiger Industrial Park, Baigang, Xiaojinkou, Huizhou, Guangdong 516000, China

Tel: +86-752-5853255, Fax: +86-752-5839222, Website: www.leader-cn.cn

生产地址：中国广东省惠州市小金口老虎岭工业园，邮政编码：516000



VIBRATION MOTOR	MODEL: 编号	REV.NO : A0
DATE: 2022.06.14	MODEL NAME: LCM04084520	PAGE : 1/10
Contents/目录		
Items/项目	Page/页码	Drawing number/图纸编号
1. 适用范围/Scope of application	2/10	
2. 使用条件/Standard operating condition	2/10	
3. 测试条件/Test Conditions	3/10	
4.机械特性/Mechanical characteristics	4/10	
5.判定基准/Requirements	5/10	
6.信赖性测试/Reliability test	6/10	
7.注意事项/Cautions	7/10	
8. 机械图/Mechanical drawing	8/10	
9.包装规范/Packing Specification	9/10	
10. 修改记录/Modify records	10/10	

VIBRATION MOTOR	MODEL: 编号	REV.NO : A0
DATE:2022.06.14	MODEL NAME:LCM0408442015	PAGE : 2/10

## 1. 适用范围/Scope of application

This product manual applies to the LCM0408 standard vibration motor .  
本产品说明书适用于 LCM0408 标准振动马达。

## 2. 使用条件/Standard operating condition

No. 序号	Items 项目	Specification 规格
2-1	额定电压 Rated voltage	3.0V DC
2-2	回转方向 Rotating direction	CW / CCW all directions 顺，逆时针方向皆可
2-3	摆放位置 Motor posture	Any posture is available 任何位置都可以
2-4	使用电压范围 Voltage range for use	2.6V~3.4V DC
2-5	轴向间隙/Shaft end play	0.05~0.25mm
2-6	可用温度范围 Allowable temperature range	1.工作温度/Working temperature:-20°C~60°C 湿度/Humidity:10~90%RH 2.保存温度/Storage temperature:-40°C~80°C 湿度/Humidy:10~90%RH
2-7	外观 Appearance	无划痕、锈蚀、污迹等不良现象/No scar,rust, stain and dent



VIBRATION MOTOR	MODEL: 编号	REV.NO : A0
DATE: 2022.06.14	MODEL NAME:LCM0408442015	PAGE : 3/10

### 3. 测试条件/Test Conditions

No. 序号	Items 项目	Measuring condition 测试条件	Specification 规格
3-1	Rated load 额定电流	Measure at rated voltage 在额定电压下测定	80mA max
3-2	Rated speed 额定转速	Measure at rated voltage 在额定电压下测	15000±3000rpm
3-3	Starting current 启动电流	Measure current at locked weight in rated voltage 在额定电压及锁定电机振子条件下测试	110mA max
3-4	Starting voltage 启动电压	Minimum voltage for starting (On / Off Test) 起动的最小电压条件作通断测试	2.0V DC Max
3-5	Terminal resistance 电枢电阻	Measure between terminals 在端子间测试	40±20%Ω
3-6	Insulation resistance 绝缘电压	Supply with DC 100V between the lead wire(shrapnel or PIN) and the vibration weight在导线(弹片或者PIN)与振动子之间提供DC 100V 电压	10MΩ MIN
3-7	Measuring condition 测试条件	Measure at normal temperature and humidity If there is any doubt about judgement,measurements shall be made within 20±2°C, 65±5%RH. 常温常湿下测定，监测应当在20±2°C, 65±5 %RH.条件下进行	

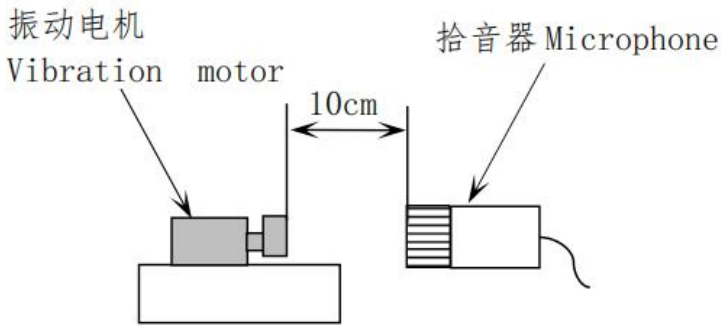
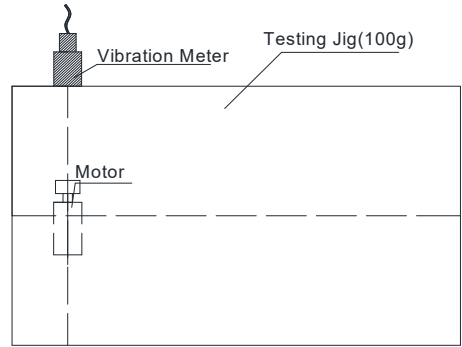
VIBRATION MOTOR		MODEL: 编号	REV.NO : A0
DATE: 2022.06.14		MODEL NAME:LCM0408442015	PAGE : 4/10
<b>4.机械特性/Mechanical characteristics</b>			
No. 序号	Items 项目	Measuring condition 测试条件	Specification 规格
4-1	电机重量 Motor Weight	用天平测量/Use scale	0.8g±0.15g
4-2	机械噪音 Mechanical Noise	额定电压及负荷下测试 背景噪音不超过30分贝 At rated voltage and rated load back ground noise: 30dB(A) max.	50dB(A) MAX
			
4-3	振动量 Vibration Strength	Grms 0.7 Min	

VIBRATION MOTOR	MODEL: 编号	REV.NO : A0
DATE:2022.06.14	MODEL NAME:LCM0408442015	PAGE : 5/10

### 5.判定基准/Requirements

NO./序号	Item/项目	Requirements/判定基准
5-1	TABLE A	1)Rated speed/额定转速：变化率在初始值±40%以内 2)Rated current/额定电流：不超过 90mA 3)Starting voltage/起动电压：2.4V DC Max
5-2	TABLE B	1)端子阻抗/Terminal resistance:变化率在初始值±10%以内 2)外形结构无异常/No abnormal appearance and structure

### 6.信赖性测试/Reliability test

6-1	振动 Vibration	Total peak amplitude（全振幅）： 1.5mm（P-P） Frequency（频率）：60Hz Period（周期）：10-55-10Hz Direction（方向）：X, Y, Z Test time（试验时间）：10 minutes at each stage （每个阶段 10 分钟）	常温常湿条件下放置2小时后，马达满足5-1、5-2的要求。 After 2 hours exposure in ordinary temperature and humidity ,motors shall be approved as specified in item 5-1、5-2.
-----	-----------------	---	--



立得微电子（惠州）有限公司

Leader Micro Electronics (huizhou) Co., Ltd

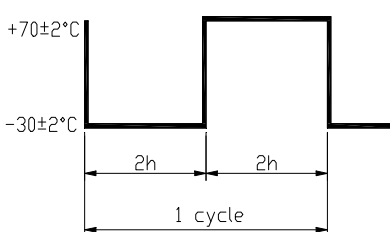
VIBRATION MOTOR		MODEL: 编号	REV.NO : A0
DATE: 2022.06.14		MODEL NAME: LCM0408442015	PAGE : 6/10
NO./序号	Item/项目	Test condition/试验件	Requirements/判定基准
6-2	Life 寿命	Voltage/电压: 3.0V DC Temperature/温度: 20°C±2°C Humidity/湿度: 60±2%RH Test model/试验形式: 1S ON 1S OFF Cycle/循环次数: 100,000cycles	在常温常湿下放置2h后, 电机性能应符合5-1、5-2要求。 After 2 hours exposure in ordinary temperature and humidity ,motors shall be approved as specified in item 5-1、5-2。
6-3	Low temp exposure 低温放置	Temperature/温度: -40±2°C Time/时间: 96hours	常温常湿条件下放置2小时后, 马达满足5-1、5-2的要求。 After 2 hours exposure in ordinary temperature and humidity ,motors shall be approved as specified in item 5-1、5-2.
6-4	High temp exposure 高温放置	Temperature/温度: +85±2°C Time/时间: 96hours	
6-5	Humidity exposure 湿度放置	Temperature/温度: +40±2°C Humidity/湿度: 90±5%Rh Time/时间: 96hours	
6-6	Thermal shock 热冲击	 <p>Test cycle/试验循环周期数:4cycles</p>	常温常湿条件下放置2小时后, 马达满足5-1、5-2的要求。 After 2 hours exposure in ordinary temperature and humidity ,motors shall be approved as specified in item 5-1、5-2
6-7	Free fall 自然落下	Set the motor to the approximately 100g(include the motor)weight of block Drop the motor on the concrete floor 将马达放在一个重100g的盒子里跌落至混凝土地面上 Height/高度: 1.5m Direction/方向: ±x, ±y, ±z Number of times /次数: Each 2times	常温常湿条件下放置2小时后, 马达满足5-1、5-2的要求。 After 2 hours exposure in ordinary temperature and humidity ,motors shall be approved as specified in item 5-1、5-2.



VIBRATION MOTOR	MODEL: 编号	REV.NO : A0
DATE: 2022.06.14	MODEL NAME:LCM0408442015	PAGE : 7/10

## 7. Cautions/注意事项

(1). Please pay attention to the voltage range of the motor. And the use of the provisions of this standard. Otherwise the service life and performance of the motor will be affected.

请注意马达电压使用范围，并在本标准规定内使用，否则马达使用寿命和性能将会受到影响。

(2). Motor can not be stored in high temperature, high humidity and corrosive gas environment.

马达不能存放在高温、高湿度和腐蚀性气体环境中。

(3). Please use the motor within 6 months, If it exceeds the storage period, you need to re check and confirm it.

请在 6 个月内使用马达，如果超过存储周期，则需要重新检查和确认。

(4). The casing surface with a small amount of rust is allowed.

机壳表面有少量锈迹是允许的。

(5). Please note that motor can not be used in high temperature, high humidity, corrosive gas and strong magnetic environment, otherwise the motor performance will be reduced

请注意，马达不能在高温、高湿度、腐蚀性气体及强磁环境中环境中使用，否则会降低马达性能。

(6). The force applied to the motor housing should be less than 3kgf, otherwise the motor performance will be affected.

施加在马达机壳上的力应小于 3kgf，否则会影响马达性能。

(7). In the process of transportation turnover and installation, it should be handled gently to avoid damaging motor due to collision.

在运输周转及安装使用过程中应轻拿轻放，以避免马达因碰撞受到损坏。



VIBRATION MOTOR	MODEL: 编号	REV.NO : A0
DATE: 2022.06.14	MODEL NAME: LCM0408442015	PAGE : 8/10

### 8. 机械图/Mechanical drawing

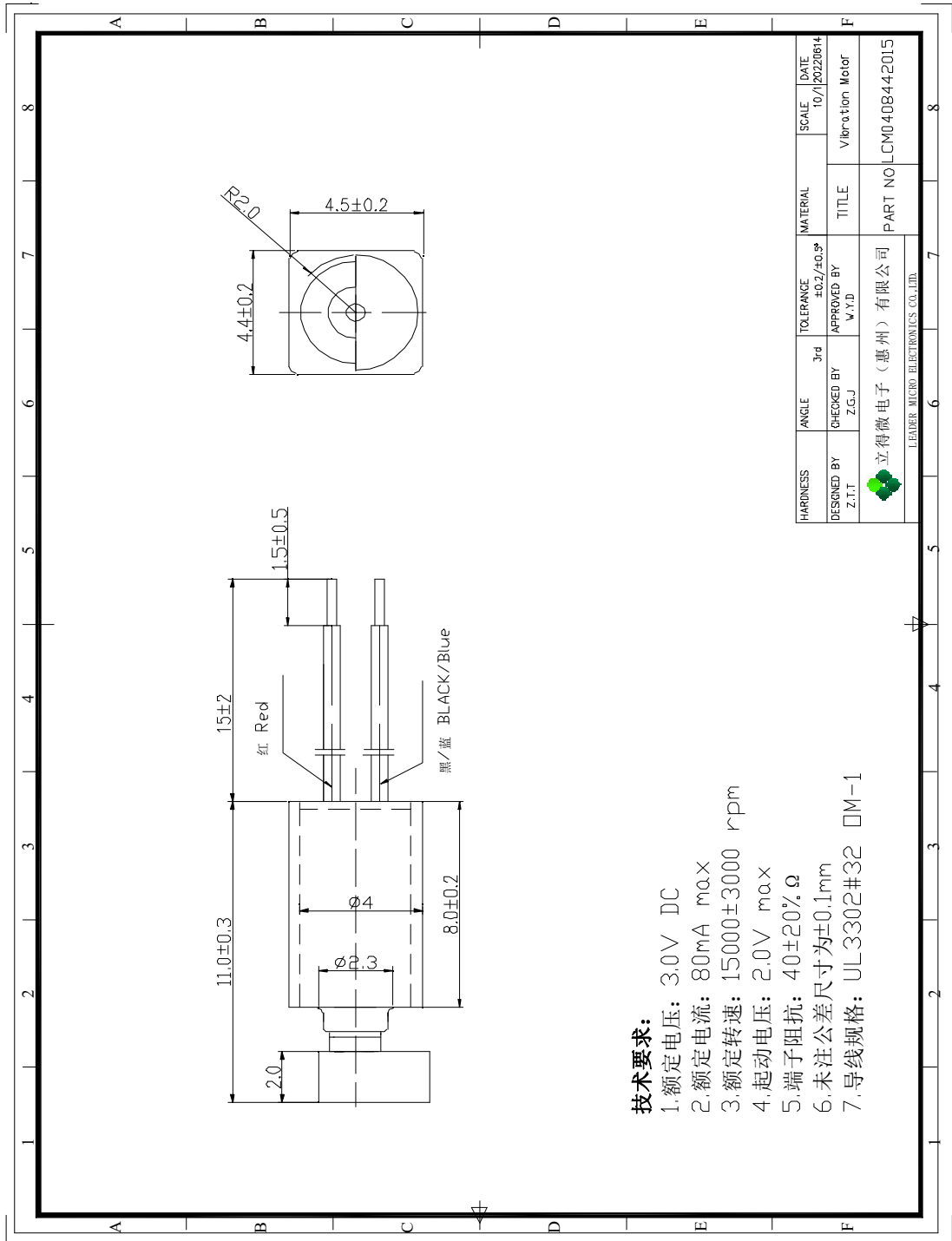

VIBRATION MOTOR	MODEL: 编号	REV.NO : A0
DATE: 2022.06.14	MODEL NAME:LCM0408442015	PAGE : 9/10

## 9.包装规范/Packing Specification

圆柱马达包装  
Pack drawing of Z7AL2 cylindrical Motor

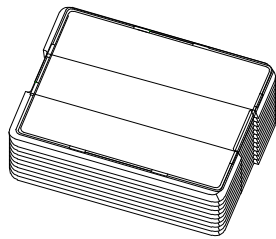

100\*25PCS<1 bundle>

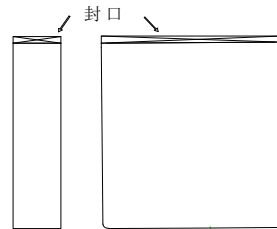

Packaging



× 2 bundle

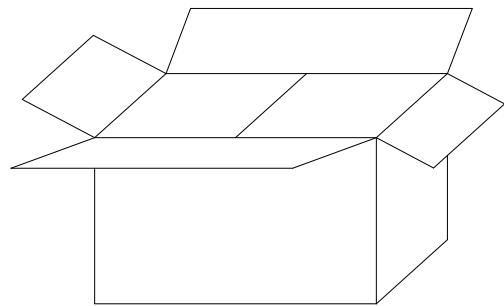

5000PCS/CTN: 35cm\*23.5cm\*15cm

10000PCS/CTN: 35cm\*23.5cm\*27.5cm

### 包装试验要求：

Packaging test requirements:  
沿外包装箱±x, ±y和±z方向, 距水泥地面1.5m高度, 各自由跌落2次, 马达应无机械损伤, 电气性能仍符合标准要求。

Along the outer packing box + X, + y and + Z direction, from the cement ground 1.5m height, the free fall 2 times, the motor should have no mechanical damage, electrical performance is still in line with the standard requirements.

