



LEADER

产品规格说明书

PRODUCT SPECIFICATION

FILLED BY BUYER	客户名称 Buyer Name	
	客户料号 Buyer Part No.	
	客户承认签章 Buyer Approved Signatures	

FILLED BY LEADER	文件编号 Spec No.	leader-3465	
	品名 Part Name	无刷振动马达 BLDC Vibrator Motor	
	型号 Model No.	LBM0625A3465F	
	样品承认日期 Date Samples Approved		
	作成 Designed by	检讨 Checked by	承认 Approved by
	张 停 停 2023. 02. 11	张 冠 军 2023. 02. 11	王 远 东 2023. 02. 11

立得微电子（惠州）有限公司

Leader Micro Electronics (Huizhou) Co., Ltd.

Tiger Industrial Park, Baigang, Xiaojinkou, Huizhou, Guangdong 516000, China

Tel: +86-752-5853255, Fax: +86-752-5839222, Website: www. leader-cn.cn

生产地址：中国广东省惠州市小金口老虎岭工业园，邮政编码：516000

规格书内容

Contents of Specifications

1. 适用范围/ Applicable Scope	1/10
2. 使用条件/ Operating Conditions	1/10
3. 测试条件/ Test Conditions	1/10
4. 初期电气性能/ Initial Electrical Characteristics	1/10
5. 机械性能/ Mechanical Characteristics	2/10
6. 耐久性能/ Reliability Characteristics	3/10
7. 标准测量方法/ Standard Measuring Method	5/10
8. 测量方法及回路图/ Measuring Method & Circuit Map	5/10
9. 使用注意事项/ Cautions in Use	6/10
10. 环境管理物质/ Environmental Management Materials:	7/10
11. 包装/ Packaging	8/10
12. 外形图/ Mechanical Drawing	9/10
13. 更改记录/ Revision Records	10/10

1. 适用范围/ Applicable Scope

本说明书适用于无刷振动电机LBM0625A系列.

This specification applies to BLDC Vibrator Motor LBM0625A series.

2. 使用条件/ Operating Conditions

项目/Item	规格/Specification
2-1	额定电压 Rated voltage 3.0V DC
2-2	使用电压范围 Operating voltage 2.7~3.3V DC
2-3	旋转方向 Rotation CW(clockwise) Lead Wire Red(+), Blue(-)连接基准 Based on connecting lead wire Red(+), Black(-)
2-4	使用环境 Operating environment -20~+60°C, 10~90%RH
2-5	保存环境 Storage environment -40~+80°C, 10~90%RH

3. 测定条件/ Testing Conditions

项目/Item	规格/Specification
3-1	温度 Temperature 25±3°C
3-2	湿度 Humidity 65±20% RH
3-3	气压 Air Pressure 1013±40 hPa
3-4	电源 Power 稳压直流电流 Constant DC Current

4. 初期电气性能/ Initial Electrical Characteristics

项目/Item	规格/Specification	条件/Condition
4-1	额定转速 Rated Speed 16000±3000 rpm	额定电压下和额定负载下。 At rated voltage and rated load.
4-2	额定电流 Rated Current 80 mA Max	
4-3	起动电流 Starting Current 175mA Max	在最小启动电压下启动，测试时需要注意，在调整适用的电压后需要断电一次，使转子进行复位。不允许从低电压到高电压连续向上调整。Start at the minimum starting voltage, the test need to pay attention to adjust the applicable voltage after the need for a power cut to reset the rotor. Continuous upward adjustment from low to high voltage is not allowed.
4-4	起动电压 Starting Voltage 2.5V DC Max	
4-6	绝缘电阻 Insulation Resistance 10MΩ Min	在100V直流下，导线和机壳间测量 At DC 100V between lead wire and case.

5. 机械性能/ Mechanical Characteristics

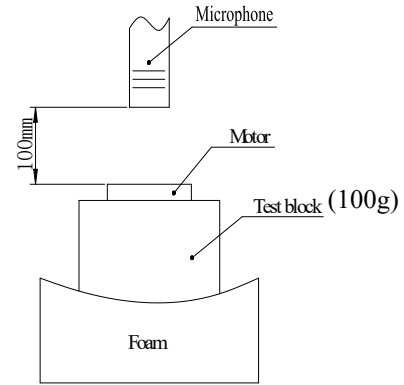
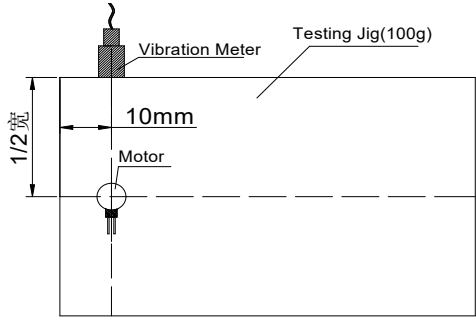
项目/Item		规格/Specification
5-1	底盖偏转强度 Bracket deflection strength	9.8N以上 ≥9.8N
5-2	机械噪音 Mechanical noise	小于50分贝. A计权 ≤50dB (A)
	<p>在额定电压下。 背景噪音：不大于28dB.A计权 电机轴向水平固定在约100g测试夹具上， 拾音器沿轴向正对电机平面。 测试距离100mm</p> <p>At rated voltage and scene noise as 28dB (A)Max, the shaft is horizontally fastened to the test jig (100g). The Microphone faces the plane of motor along The shaft . The distance is 100mm.</p>	
5-3	Vibration Test 振动测定	0.4G Min(AVG)
		

6. 耐久性能/ Reliability Characteristics

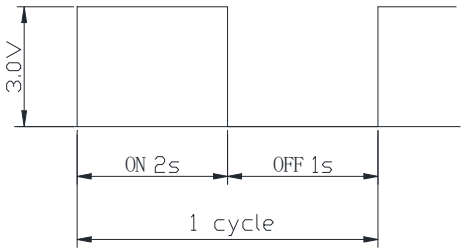
项目/Item	规格/Specification	判定标准/Judgment
6-1 寿命 Life	 <p>试验循环 /Test cycle: 500,000 cycles</p>	<p>在常温常湿下放置4h后，电机性能应符合以下要求。</p> <ol style="list-style-type: none"> 1)额定转速:指标不低于初始值-30%；不高于初始值+40% 2)额定电流:指标在初始值±30%以内。 3)起动电压:2.5V DC Max直流电压。 <p>After 4h exposure in the ordinary temperature and humidity,the motor's performance should accord with below requirements:</p> <ol style="list-style-type: none"> 1)Rated speed:Data-30% Initial Min, Data+40% Initial Max. 2)Rated current:Data±30% Max. 3)Starting voltage: 2.5V DC Max

项目/Item		规格/Specification	判定标准/Judgment
6-2	低温放置 Low Temperature Exposure	温度 /Temperature: $-40 \pm 2^{\circ}\text{C}$ 时间 /Time: 96h	<p>在常温常湿下放置4h后，电机性能应符合以下要求。</p> <p>1)额定转速:指标在初始值$\pm 30\%$以内。 2)额定电流:指标在初始值$\pm 30\%$以内。 3)起动电压:2.5V DC Max.</p> <p>After 4h exposure in the ordinary temperature and humidity, change rates of the motor's performance should accord with below requirements:</p> <p>1)Rated speed: within $\pm 30\%$ of initial value. 2)Rated current: within $\pm 30\%$ of initial value. 3)Starting voltage: 2.5V DC Max</p>
6-3	高温放置 High Temperature Exposure	温度 /Temperature: $+ 80 \pm 2^{\circ}\text{C}$ 时间 /Time:96h	
6-4	湿度放置 Humidity Exposure	温度 /Temperature : $+ 60 \pm 2^{\circ}\text{C}$ 湿度 /Humidity: 90 ~ 95%RH 放置时间 / Exposure time : 96h 无水气凝结 /No condensation of moisture	
6-5	振动 Vibration	频率 /Frequency: 10~55Hz 加速度 /Acceleration: 22m/s ² 周期 /Period: 10 Minutes log sweep (1.0G), (10~55~10Hz) 条件 /Condition: This motion shall be applied for a period of 10 minutes in direction of X, Y, Z.	
6-6	自然跌落 Free fall	试验状态: 将马达固定在约100克(包括马达本身)的物体上, 落向水泥地面。 Test state: Set the motor to a block of an approx. 100g weight (including the motor) and drop it onto the concrete floor. Height: 1.5m Direction : $\pm x, \pm y, \pm z$ Number of times: 3 times each direction Shock: 29420m/s ² equivalent to 3000G.	

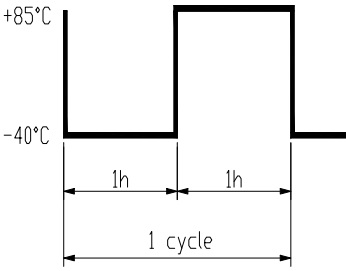
项目/Item		规格/Specification	判定基准 / Requirements
6-7	滚筒试验 Barrel roll test	滚筒高度: 1.0M 滚筒次数: 300次. 滚筒速率: 13 ± 1次/分钟 滚筒治具: 包括马达100g Height: 1.0M Times: 300 times. Speed: 13 ± 1 times/Minute Drum fixture: including motor 100g	在常温常湿下放置4h后, 电机性能应符合以下要求。 1)额定转速:指标在初始值±30%以内。 2)额定电流:指标在初始值±30%以内。 3)起动电压:2.5V DC Max. After 4h exposure in the ordinary temperature and humidity, change rates of the motor's performance should accord with below requirements: 1)Rated speed: within ±30% of initial value. 2)Rated current: within ±30% of initial value. 3)Starting voltage: 2.5V DC Max
6-8	热冲击 Heat stock test	 <p>试验循环 /Test cycle:32cycles</p>	在常温常湿下放置4h后, 电机性能应符合以下要求。 1)额定转速:指标在初始值±30%以内。 2)额定电流:指标在初始值±30%以内。 3)起动电压:2.5V DC Max. After 4h exposure in the ordinary temperature and humidity, change rates of the motor's performance should accord with below requirements: 1)Rated speed: within ±30% of initial value. 2)Rated current: within ±30% of initial value. 3)Starting voltage: 2.5V DC Max

7. 标准测量方法/ Standard Measuring Method



振动量测试仪
Vibration meter

马达安放装置
Test Jig (for
Clamping
the Motor in Place)

马达综合测试仪
Multi-functional
Test Mete

波形脉冲显示
Oscilloscope

噪音测试仪
Noise Test Meter

8. 测量方法及回路图/ Measuring Method & Circuit Map

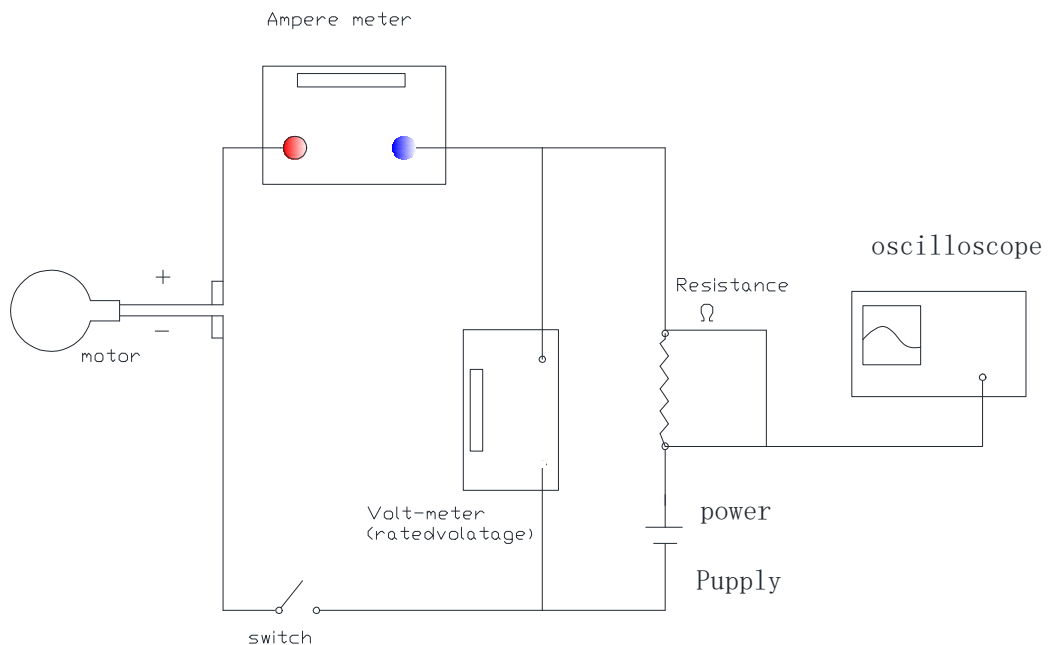

9. 使用时注意事项/ Caution in Use

9-1.与规格不同使用的情况下,性能和寿命会发生问题.希望注意电压使用范围.

You might encounter functional and life problems if you use it different from the standard . Please be careful of the range of use, like voltage etc.

9-2. MOTOR使用时,一定要把图纸上的lead wire (+极)端子连接在供电电源的 (+极), (-极) 端子连接在供电电源的(-极)后使用, 否则电机会烧坏。

Motor use, be sure to draw on the lead wire (+ Pole) terminal connected to the power supply (+ Pole) , (- pole) terminal connected to the power supply (- pole) after use, otherwise the MOTOR will burn out

9-3. 在有害GAS及高温高湿的场所保管对马达造成不良因素所以请注意保管.

Please be careful of that the storage in high temperature and humidity and noxious gas might cause hindrances to motors.

9-4.为了减少马达旋转时因检查失误电源端子短路时 导致 Drive IC 损伤。为了防止损伤 Drive IC 电源端子间(+, -) 把 $2\mu\text{F}$ 以上的电容器并列链接 在 Motor 后实施检查是安全措施

Drive IC can be damaged by power plug short due to careless test. In order to prevent damage of Driver IC, please connect $2\mu\text{F}$ condenser to motor in a row(parallel connection) with power plug(+/-).

9-5.拿取马达时,尽可能的轻拿Case部分. Please hold the case part lightly as much as you can when you use motors.

9-6.为保护Drive IC, 请不要施加DC 3.8V以上.

Please do not use above DC 3.8V for preventing Driver IC.

9-7.马达接近磁性物质或接触时会降低马达性能, 因此避免接近强磁场.

Please avoid being near and contacting magnetic materials like magnet which might encounter functional problems.

9-8.能够自我吸附的物质(铁, 粉末) 及灰尘等与马达混放时会出现转动不良, 异常音等, 会使马达的性能下降及信赖性受影响,因此取用及作业时应注意环境清洁.

If some materials(metal, powder) and dust become mixing condition in the motor it might cause feature declines by occurring rotation faulty and abnormal sound so please be clean the working environment and careful when you deal with the motor.

9-9.注意请不要浸泡在液态物质如: 水或酒精中.

Please be careful of not soaking in liquid like water or alcohol.

9-10.包装方法:(参照包装图) 只有在客户要求下变更可能.

Packing method :Refer to packing drawing. But, it could be changed on user' s demand.

9-11.无法保证满足本式样范围以外使用的情况.

It can' t guarantee if the motors are used out of the range of fulfilling this specification.

9-12.本式样书内容的变更及追加是在双方协议下实施.

Any further conditions or change of this APPROVAL REQUEST take effect by mutual consent.

9-13马达必须在出厂后的六个月内组装到终端设备上。如马达超过6个月未使用, 建议在使用前首先通电激活马达(供电3-5秒), 以达到最佳振动效果。The motor must be assembled to the terminal device within six months of shipping date. If the motor has not been used for more than six months, it is recommended to activate the motor with electricity (powered on for 3-5 seconds) before use to achieve the best vibration effect.

10. 环境管理物质/ Environmental Management Materials:

本产品应符合RoHS 指令要求和无卤素要求。

The product should be in compliance with RoHS/ REACH requirements:

* 镉及其化合物最大允许含量为100PPM

Cadmium and Compound: $\leq 100\text{PPM}$

* 铅及其化合物最大允许含量为1000PPM

Lead and Compound: $\leq 1000\text{PPM}$

* 汞及其化合物最大允许含量为1000PPM

Hydrargyrum and Compound: $\leq 1000\text{PPM}$

* 六价铬及其化合物最大允许含量为1000PPM

+6 Chromium and Compound: $\leq 1000\text{PPM}$

* 多溴联苯及其化合物最大允许含量为1000PPM

PBB and Compound: $\leq 1000\text{PPM}$

* 多溴二苯醚及其化合物最大允许含量为1000PPM

PBDE and Compound: $\leq 1000\text{PPM}$

* 氯溴两种卤素之和最大允许含量为1500PPM

The allowed content of Cl and Br is 1500PPM Max for total.

* 氯卤素最大允许含量为900PPM

The allowed content of Cl is 900PPM Max.

* 溴卤素最大允许含量为900PPM

The allowed content of Br is 900PPM Max.

11. 包装/ Packaging:

振动马达包装 Pack drawing of Vibrator Motor

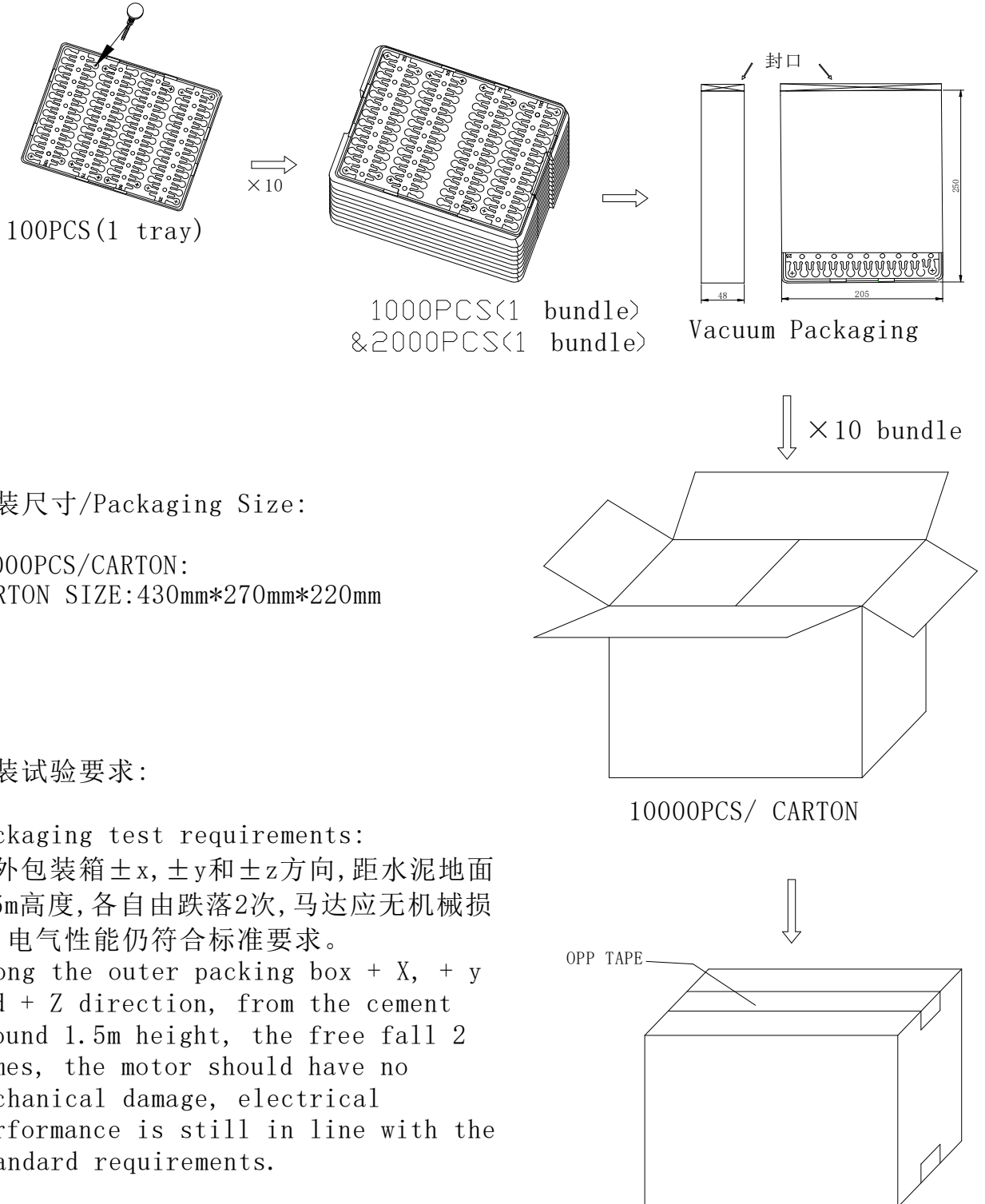

12. 外形图/ Mechanical Drawing:

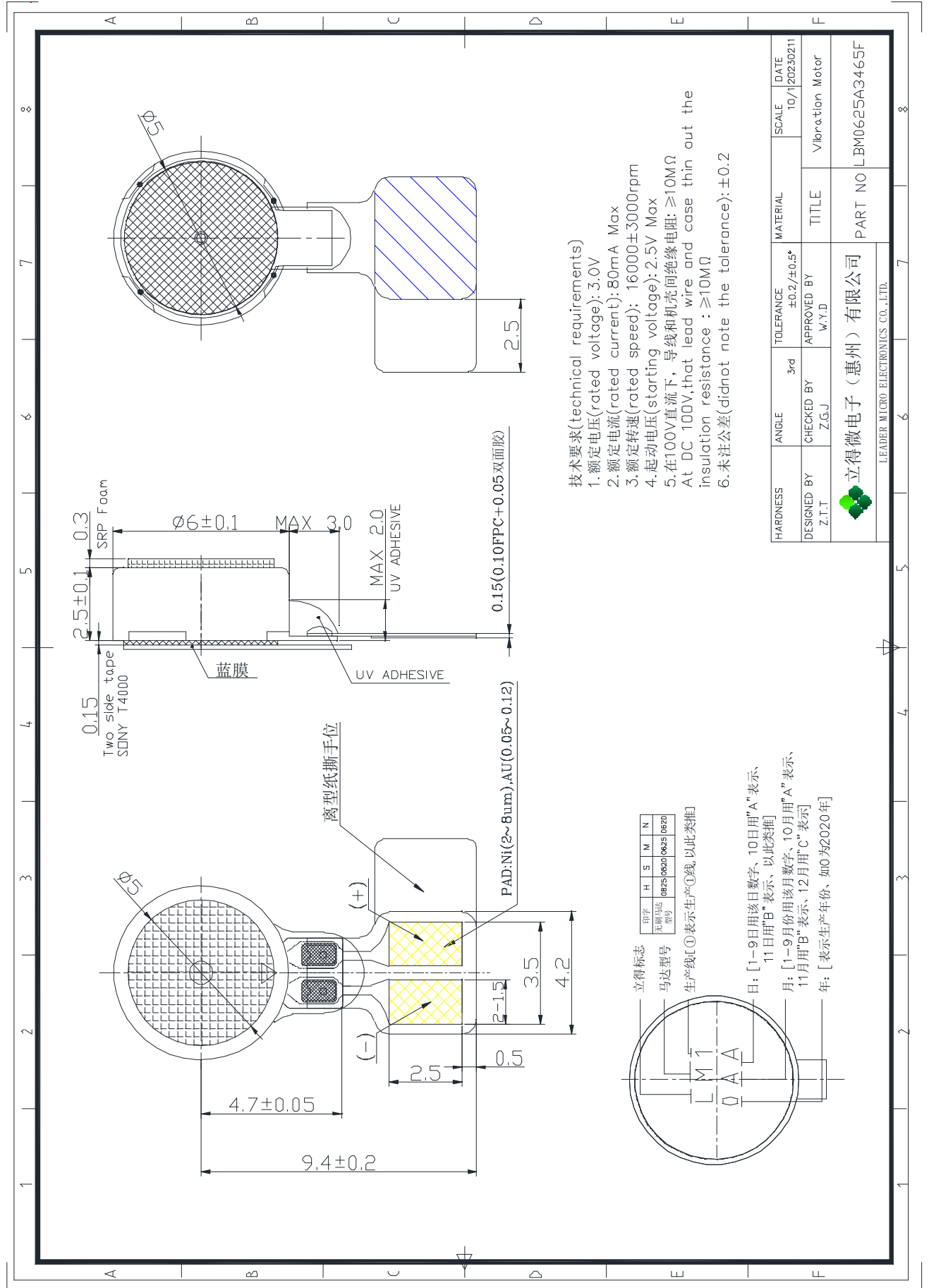

2023.02.11(REV,0)	说明书/Specification	编号/No.: leader-3465	10/10
-------------------	-------------------	---------------------	-------

13. 更改记录/ Revision Records:

CUSTOMER 顾客		SPEC NO 规格书号	编号/No.: leader-3465
PRODUCT MODEL 产品型号	LBM0625A3465F	DATE 日期	2023.02.11

REVISION RECORDS 修改记录表

REV NO 修改号	DATE 日期	PAGE 页码	REVISION ITEM 修改项目	REASON 更改原因
REV,0	2023.02.11	/	产品发布	